

Installation Instruction

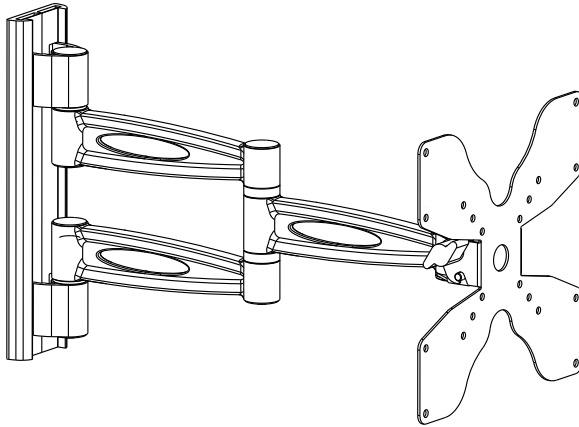

UNPACKING INSTRUCTIONS

- Carefully open the carton, remove contents and lay out on cardboard or other protective surface to avoid damage.
- Check package contents against the Supplied Parts List in the next page to assure that all components were received undamaged. Do not use damaged or defective parts.
- Carefully read all instructions before attempting installation.

IMPORTANT SAFETY INFORMATION

Install and operate this device with care. Please read this instruction before beginning the installation, and carefully follow all instructions contained herein. Use proper safety equipment during installation.

Please call a qualified installation contractor for help if you:

- If you don't understand these directions or have any doubts about the safety of the installation.
- If you are uncertain about the nature of your wall, consult a qualified installation contractor.

Do not use this product for any purpose or in any configuration not explicitly specified in this instruction. We hereby disclaims any and all liability for injury or damage arising from incorrect assembly, incorrect mounting, or incorrect use of this product.

Supplied Parts List

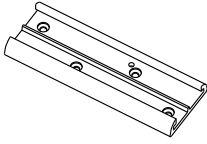

(1)Wall Plate-a

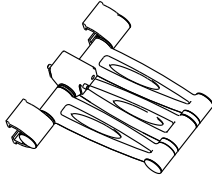

(1)Arm Assembled-b

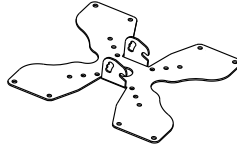

(1)Mornitor Bracket-c

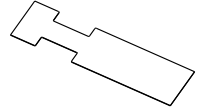

(1)Screw Cover-d



(4)M4x12 Bolt-e

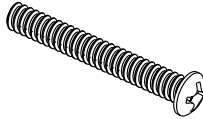

(4)M4x30 Bolt-f

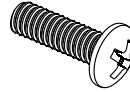

(4)M6x12 Bolt-g

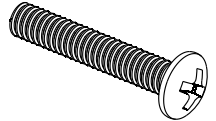

(4)M6x35 Bolt-h



(8)M4 Washer-i



(6)M6 Washer-j

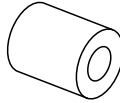

(4)M4/M6 Space-k

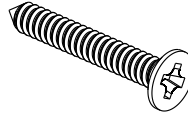

(4)Lag Bolt-l

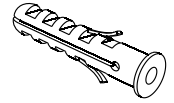

(4)Concrete Anchor-m

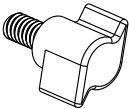

(2)Safety Knob-n

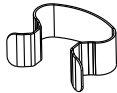

(2)Cable Ring-o

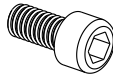

2 x Allen Bolt (p)



2 x Spring Washer (q)

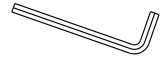

1 x Allen Key (r)



WARNING

CAUTION!

This TV mount must be securely attached to the vertical wall. If the mount is not properly installed it may fall, resulting in possible injury and/or damage.

Tools Required

- 3.8mm Drill Bit
- Phillips Screwdriver

- 8mm Masonry Bit
- Carpenter's Level

Note: The mounting components and hardware supplied in this package are not designed for installations to walls with steel studs or to cinder block walls. If the hardware you need for your installation is not included, please consult your local hardware store for proper mounting hardware for the application.

Brick Mount

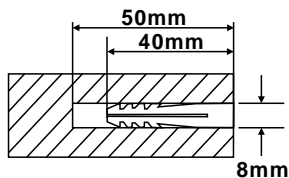

Make sure the stop screw is on the bottom side when do this step.

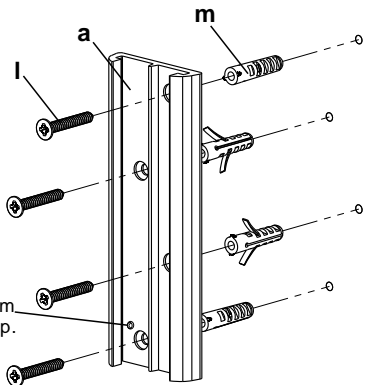

Wood Mount

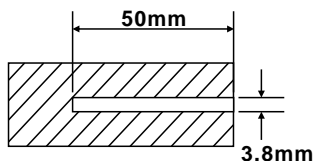

Make sure the stop screw is on the bottom side when do this step.

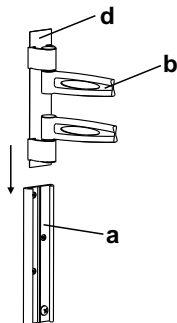
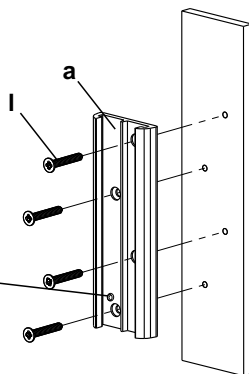

1. Before do this step, make sure the Wall Plate(a) had been fixed on the wall.

2. Put the Screw Cover(d) on the Arm Assembled(b).

3. Inter the Arm Assembled as showed in the left picture.

Step 3

Mounting the Monitor Bracket to a TV

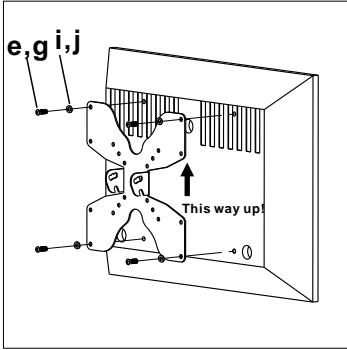

For Flat Back TV

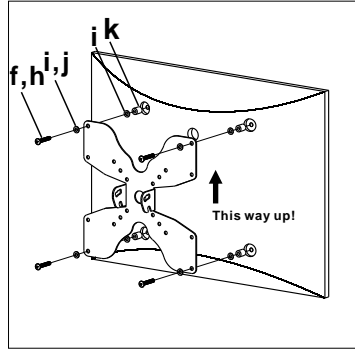

For Curved Back TV

Step 4

Attaching TV to Wall Plate and Adding the Knobs

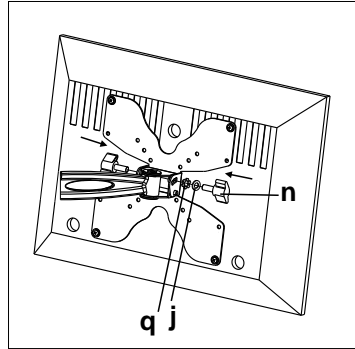
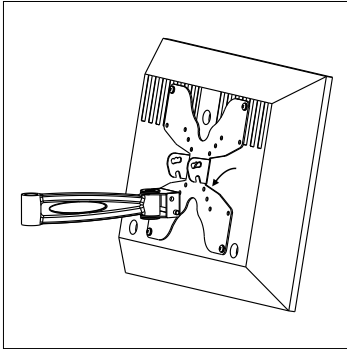

Remarks: You can use the supplied 2pcs Allen Bolt (p) to instead of plastic knobs if you have problem to fix the TV tilting angle.

Step 5

Install the Cable Management Ring on the Arm

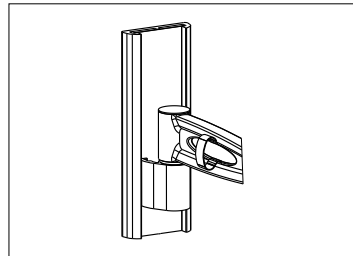
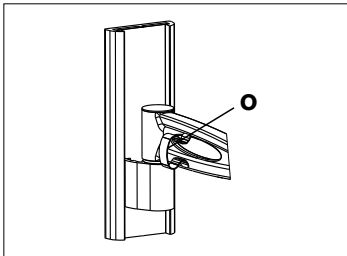

Thanks for choosing our products, enjoy the using.